



ACCENTRONIX
The access control system *that keeps you safe*

Product Introduction



ACCENTRONIX

The access control system *that keeps you safe*

ABOUT US

- Accentronix specialize in developing and manufacturing of **Access Control Systems** for **Security Estates** specifically tailored for the **South African** market.
- 100% South African.
- 22 Years of inhouse electronic design, manufacturing and software development.
- Almost 2 Million people using our system for access control every day.
- More than 15 000 security estates on our profile.
- Unmatched Technical Support (7 days a week).
- **All-in-One, Plug & Play, Easy to install and use Access Control system for Security Estates**



FEATURES

- We have a Feature-rich, easy to use website for centralized management of Users, Remotes, Tags, Faces and Visitors.
- Wireless Intercom (4G/LTE, Bluetooth, OTP)
- Facial Recognition (Easy-Connect, Plug-and-Play).
- Cloud-linked Remotes - Nova and NICE.
- UHF Car Window Tags.
- OTP Keypads.
- License Disk Scanners.
- Mobile App.
- All of our devices can work either stand-alone or seamlessly as a one powerful cloud-connected access control system.



Entrance Gate



Typical Security Estate



Exit Gate



Wireless Intercom
Visitor OTP



Faces



App



Cloud linked
Remotes



License Disk
Scanner



UHF Car Window
RFID tags



License Disk
Scanner



Cellswitch with
Cloud linked
Remotes



Visitor OTP



Faces

Pedestrian Gate



All-in-One
Cloud Connected
Access Control Platform



Cellswitch with Cloud linked Tags



Visitor OTP



Faces



WEBSITE

Electric Fence



Advanced monitoring and control via the Energizer keypad interface



Cellswitch Nano



App

Key Product Range



Cellswitch Infinity

- Control your gate with your mobile phone.
- 4G/LTE, Bluetooth & WiFi.
- Manage 10 000 Users, remotes, tags and faces.
- Licence disk scanner.
- Visitor One-Time-Pin.
- Wired & Wireless Bluetooth Keypads.
- Advanced Electric Fence Interface.
- UHF Car Window Tag Reader Interface.



Cellswitch Nano & Nano Plus

- Control your gate with your mobile phone.
- 4G/LTE & Bluetooth.
- Nano: 10 Users Nano Plus: 10 000 Users
- Manage Users, remotes, tags and faces.
- Licence disk scanner.
- Facial Recognition.
- Visitor One-Time-Pin.
- Wired & Wireless Bluetooth Keypads.
- Advanced Electric Fence Interface.
- UHF Car Window Tag Reader Interface.



Wireless Intercom

- 4G/LTE & Bluetooth.
- Calls directly to your mobile phone.
- Cristal Clear sound via VoLTE.
- Visitor One-Time-Pin.
- Manage 10 000 Users, remotes, tags and faces.
- Licence disk scanner.
- Facial Recognition.
- Wired & Wireless Bluetooth Keypads.
- UHF Car Window Tag Reader Interface.

Add-on Products



License Disk Scanner

- We perfected this technology!
- Fully integrated with the Accentronix eco-system.
- The most advanced and feature rich scanner on the market.
- OTP integration and calls directly to resident's mobile phones.
- 4G/LTE Sim and WiFi.



Easy-Connect Facial Recognition

- Effortless Plug and Play installation.
- Standalone OR fully integrated with all Intercom and Cellswitch devices.
- Can be installed and configured in minutes by anyone.
- No special training or PC needed.
- Users enroll their own faces through the Accentronix Smart Home App.
- 4G/LTE Sim with Fibre backup internet.



Wired & Wireless Bluetooth Keypads (OTP)

Wired Keypad:

- Backlit Keys
- 30m maximum cable length
- Connects to any of our products.

Wireless Keypad:

- 30m wireless range
- Connects to any of our products.
- Battery life: 20 000 OTP's

Add-on Products



Connection on Intercom or Cellswitch

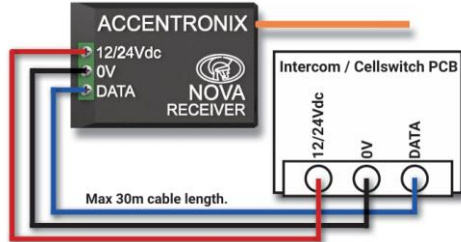

Cloud-Linked Nice and Nova Remotes

- Restricted time-based access control for domestic and gardening services specific days and times.
- Monitor, manage and block remotes and users from anywhere.
- Comprehensive log reports.
- Feature-rich, easy to use website for centralized management.
- Connects to any Intercom or Cellswitch.



Smart Tags

- Manage your tags online.
- Exact same features as the Cloud-Linked Remotes



Tag reader interface



ZkTeco UHF 10 Pro



UHF Car Window Tag Reader

- Restricted time-based access control.
- Monitor, manage and block cars and users from anywhere.
- Comprehensive log reports.
- Feature-rich, easy to use website for centralized management.
- Connects to any Intercom or Cellswitch.
- Uses the ZkTeco UHF 10 Pro Reader and UHF1-TAG2 tags.

Accentronix Smart Home app

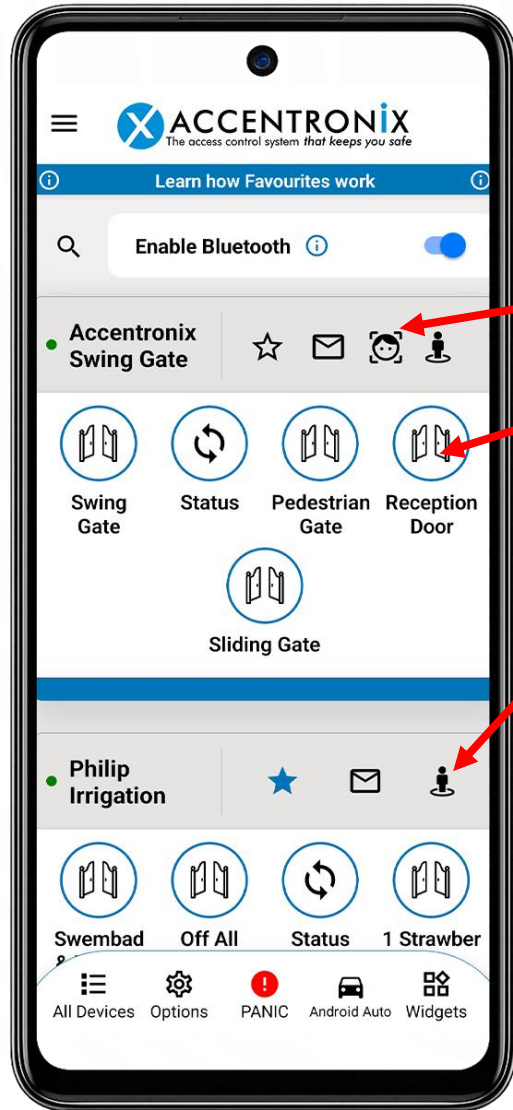

- One App to control them all.
- **Residents add their own faces using the app.**
- Access control via Bluetooth or Internet.
- Create Visitor OTP's.
- Monitor and Control Electric Fences.



Easy-Connect Facial Recognition (Hikvision)

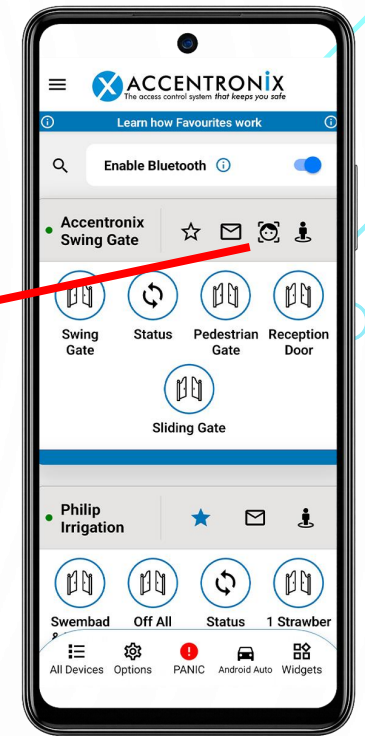

Easy-Connect PoE Cloud Hub

• [Click here for More](#)

- Effortless Plug-and-Play installation.
- **Residents add their own faces using the app.**
- Can be installed and configured in minutes by anyone.
- No special training or PC needed.
- 4G/LTE Sim with Fibre backup internet.
- Anti-passback and advanced admin control.
- **Works on any HikVision Facial Terminal.**

Invite a Visitor

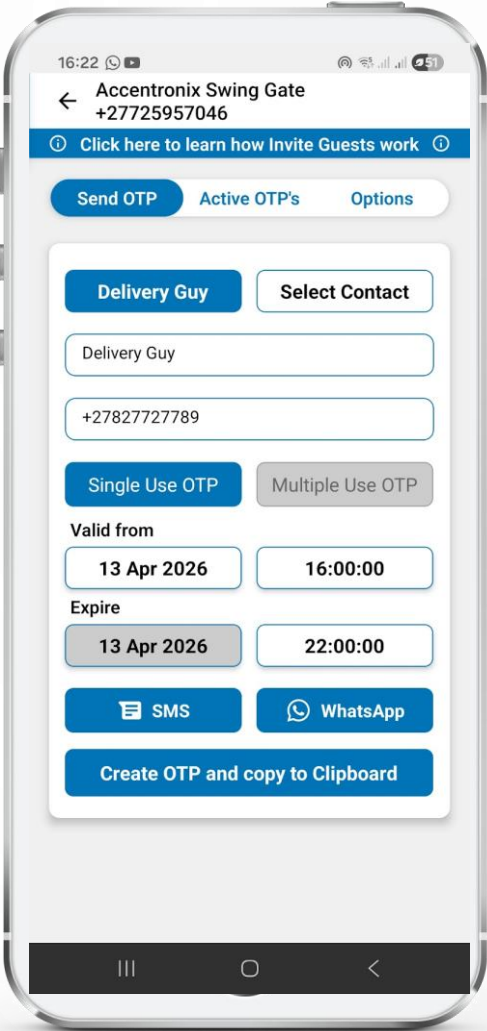

WhatsApp

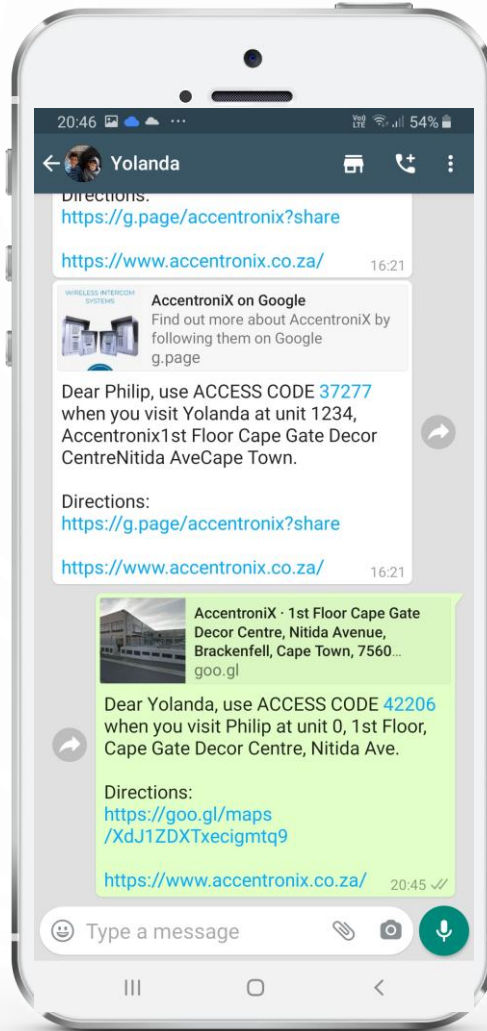

Notifications

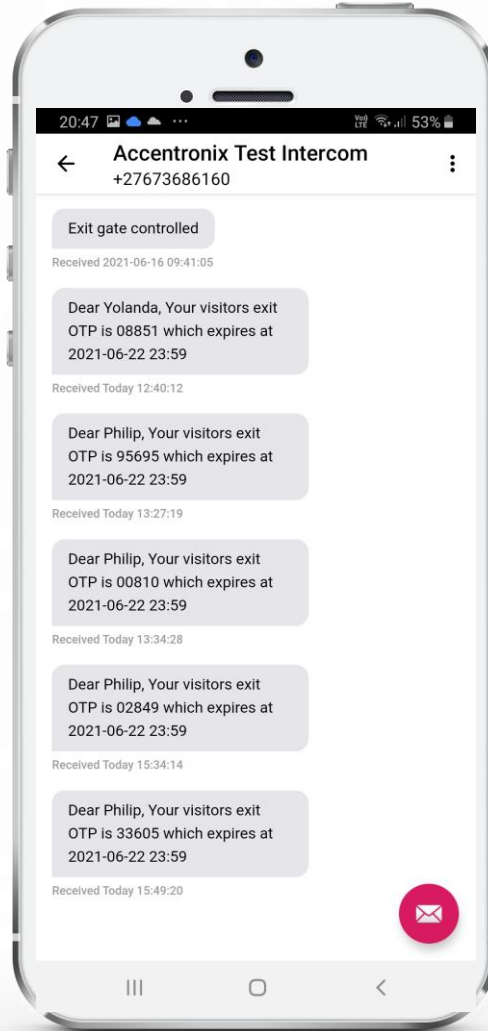

UHF Car Window Tag Reader (ZkTeco)



UHF Reader Interface



ZkTeco UHF 10 Pro



UHF1-TAG2 tags

UHF Car Window Tag Reader (ZkTeco)

- Connects to any Intercom or Cellswitch.
- Restricted time-based access control.
- Monitor, manage and block cars and users from anywhere.
- Comprehensive log reports.
- Feature-rich, easy to use website for centralized management.
- Uses the **ZkTeco UHF 10 Pro** Reader and **UHF1-TAG2** tags.

Advanced Electric Fence Control

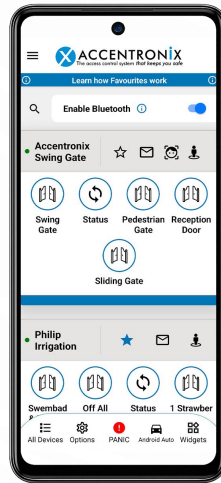
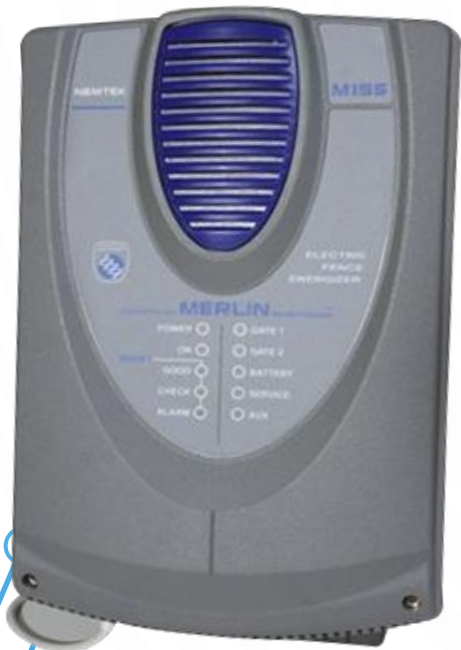

Connect the **Keypad Data Bus** of any Nemtek energizer to a Cellswitch.

- Remotely program the energizer via the App.
- Arm and disarm zones.
- Timers to automatically switch High/Low Power and On/Off.
- Get alarm and status notifications.
- Fence health and battery status.

JVA Electric Fence



Connect to your electric fence Keypad bus to a Cellswitch and have full control and monitoring on your Accentronix App.

- Send keypad programming codes to device through our app to program energizer.
- Arm and disarm with missed-call or app buttons.
- Get alarm and status notifications on our Accentronix app.
- Fence voltages and battery status

Typical Security Estate



Electric Fence
Advanced Monitoring and Control

Entrance Gate
4G/LTE & Bluetooth

Exit Gate
4G/LTE & Bluetooth

Pedestrian Gate
4G/LTE & Bluetooth

Swimming pool
9AM – 8PM

MiFare Tags

Cloud-Linked Remotes

Visitor Exit OTP
Wired and Wireless

Mobile App

Licence Disk
Scanner

Plug & Play Facial
Recognition

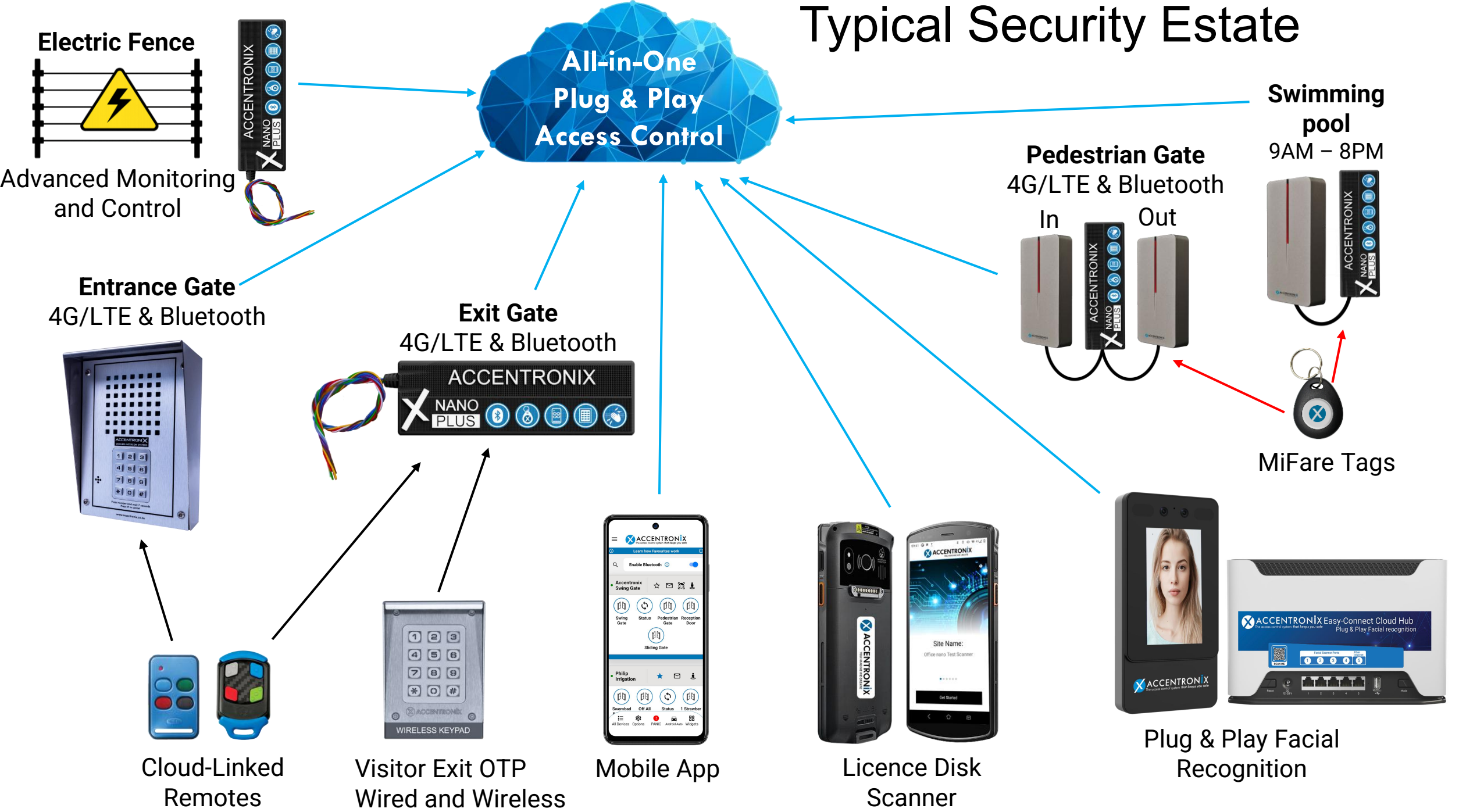

Sim Cards and Outgoing calls



- All our 4G/LTE devices comes with a pre-activated PIN Protected, working Vodacom Contract Sim.
- Sim cards stay active for one year while unregistered on the shelf.
- The 12 month free subscription starts as soon as the device is registered.
- All services are Free for the first 12 Months i.e. the subscription only needs to be paid after 1 year.
- Only airtime for outgoing calls on the Intercom and License disk scanner needs to be loaded by the client. Data is managed by Accentronix.

Subscription – Free for the first year

- All our 4G/LTE devices comes with a pre-activated working Vodacom Contract Sim. All data and services are Free for the first 12 Months.
- Only airtime for outgoing calls on the Intercom and License disk scanner needs to be loaded by the client. Data is managed by Accentronix.

Home Use

- Intercom 2-button – Free if less than 10 users.
- Cellswitch Nano – R99 excl VAT per year.

Security Estate and Electric Fence Use – Per Year

Intercom and Cellswitch – Up to 10 000 users.

- R460 for the sim + R3 per user per year (Excl VAT)
- Airtime for outgoing intercom calls not included.
- Free Welcome WhatsApp's.

License Disk Scanner

- R350 excl VAT per month (Billed annually or monthly)

Easy-Connect Facial Recognition System

- R350 excl VAT per month (Billed annually or monthly)





ACCENTRONIX
The access control system *that keeps you safe*

Setting up your device
in a snap

www.accentronix.co.za

QUESTIONS? CALL: 021 330 5016

COMPLAINTS SUPPORT



- HOME
- OUR COMPANY
- PRODUCTS
- MEDIA
- DISTRIBUTORS
- PORTAL LOGIN
- GET IN TOUCH



CLOUD LINK FOR SECURITY ESTATES

The access control system **that keeps you safe**

Our system is integrated with NICE Remotes



CONTACT US



Welcome to Accentronix
The access control system that keeps YOU safe

[Learn more »](#)

Register New Device

- MENU
-  Global Dashboard
 -  Device List
 -  **Register Device**

Step 1 > Step 2 > Step 3

Register Device

Device Name:

Device Mobile Number:

By registering a device, you agree to the [terms and conditions](#).

[Previous](#) [Next Step](#)

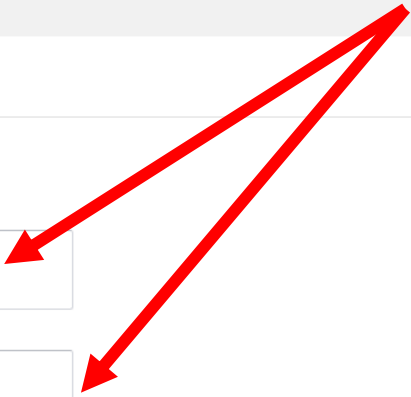

MENU

- Global Dashboard
- Device List

WILLOW GLEN

- Dashboard
- Access Control**
- Users
- Remotes, Tags & Keypads
- Gate Timers

- Configuration
- Device Logs
- Share Device

Willow Glen

Online Subscription: Feb 2022 Sms Credits: 308

Sim 1 +27 [] 26 R132.65
Sim 2 +27 [] 31 R28.70

- Access control users**
- Restricted Users
- Manage Welcome SMS
- Linked Devices

List of access control users

Name	Mobile	House	Button	Access	Enable Button	Alerts	Notes
				<input checked="" type="checkbox"/>	<input checked="" type="checkbox"/>	<input type="checkbox"/>	+ Add
Accentronix test	+27 []	000	000	<input checked="" type="checkbox"/>	<input checked="" type="checkbox"/>	<input type="checkbox"/>	📄 📶 🗑️
Accentronix test2	+27 []	9999	9999	<input checked="" type="checkbox"/>	<input checked="" type="checkbox"/>	<input type="checkbox"/>	📄 📶 🗑️
Adeline	+27 []	8	38	<input checked="" type="checkbox"/>	<input checked="" type="checkbox"/>	<input type="checkbox"/>	📄 📶 🗑️
Arisha	+27 []	9	39	<input checked="" type="checkbox"/>	<input checked="" type="checkbox"/>	<input type="checkbox"/>	📄 📶 🗑️
Arul	+27 []	16	16	<input checked="" type="checkbox"/>	<input checked="" type="checkbox"/>	<input type="checkbox"/>	📄 📶 🗑️
Arul Wife	+27 []	16	316	<input checked="" type="checkbox"/>	<input checked="" type="checkbox"/>	<input type="checkbox"/>	📄 📶 🗑️
Athol	+27 []	18	318	<input checked="" type="checkbox"/>	<input checked="" type="checkbox"/>	<input checked="" type="checkbox"/>	📄 📶 🗑️
Audrey	+27 []	19	319	<input checked="" type="checkbox"/>	<input checked="" type="checkbox"/>	<input type="checkbox"/>	📄 📶 🗑️
Brenice	+27 []	5	35	<input checked="" type="checkbox"/>	<input checked="" type="checkbox"/>	<input type="checkbox"/>	📄 📶 🗑️
Brian Gate Keeper	+27 []	99	399	<input checked="" type="checkbox"/>	<input checked="" type="checkbox"/>	<input type="checkbox"/>	📄 📶 🗑️
Charles	+27 []	10	310	<input checked="" type="checkbox"/>	<input checked="" type="checkbox"/>	<input type="checkbox"/>	📄 📶 🗑️

Add Access Control Users

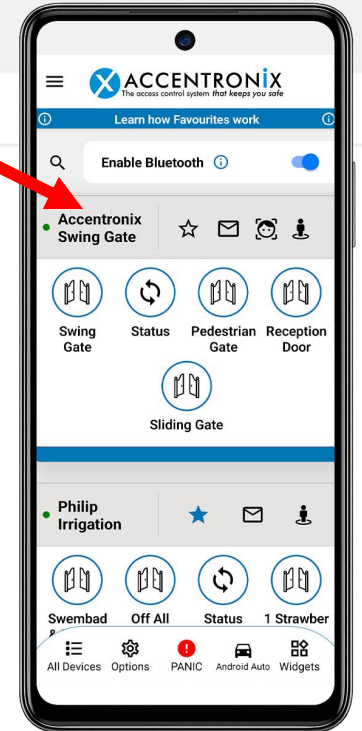

Welcome Whatsapp

MENU

- Global Dashboard
- Device List

ACCENTRONIX DOOR

Dashboard

Access Control

Users

Remotes, Tags & Keypads

Gate Timers

Configuration

Device Logs

Share Device

Accentronix Door

Online Subscription: Dec 2021 Sms Credits: 42

Sim 1 +27 [] 24

Sim 2 +27 [] 19

Restricted Users

- Access control users
- Restricted Users**
- Manage Welcome SMS
- Linked Devices

List of restricted users

Search []

Name	Mobile	House	From	To	Access Days	Gate Restriction	Expire Time	Expire Date	Expire	Notes
			07:00	17:00	M T W T F S S	Allow all	None	None	<input type="checkbox"/>	+ Add
Domestic	+27 []	12	07:00	17:00	M T W T F S S	Allow all	None	None	<input type="checkbox"/>	
Gardening	+27 []	0	07:00	17:00	M T W T F S S	Allow all	None	None	<input type="checkbox"/>	
Plumber	+27 []	2	07:00	17:00	M T W T F S S	Allow all	07:00	2021-05-28	<input checked="" type="checkbox"/>	

Showing 1 to 3 of 3 entries

ACCENTRONIX DOOR

Online Subscription:

Sim 1 +27 [input]
Sim 2 +27 [input]

Access control user

List of access contr

Name
[input]
apple test number
Claudius
Eben
Elsa
Lizelle
Philip
sean
Sean
Shantelle
Yolanda

Showing 1 to 10 of 10 entries

Gateway DemoCase on Wheels-Intercom

Reference	Device to Control	Output
Remote	Accentronix Door	1

Quick Learn Remote



Quick Learn Remote

Save Close

MENU

🏠 Global Dashboard

📋 Device List

ACCENTRONIX DOOR

🏠 Dashboard

👤 Access Control

👤 Users

📶 Remotes, Tags & Keypads

🕒 Gate Timers

⚙️ Configuration

📋 Device Logs

🔗 Share Device

Accentronix Door

Online Subscription: Dec 2021 Sms Credits 42

Sim 1 +27 [] 23

Sim 2 +27 [] 19

Save Settings Update Device

Off-site bulk-learning of Remotes & Tags

Remotes Tags Keypads

Manage Pre-Registered Remotes 2

Enable E.T. NICE - Accentronix Receiver



List of remotes linked to users

Search [] [] []

Serial No	Reference	Button	Device to Control	Resident Name	Mobile No	Unit No	Enabled	Manage
142	Remote	1	Accentronix Door	apple test number	+27 []	1	Yes	📶 🗑️
142	Gate 1	3	Accentronix Door	Shantelle	+27 []	8	Yes	📶 🗑️
142	Gate 2	1	Accentronix Door	Shantelle	+27 []	8	Yes	📶 🗑️
142	Elsa personal	1	Accentronix Door	Elsa	+27 []	3	Yes	📶 🗑️
2551	Door remote	1	Accentronix Door	Elsa	+27 []	3	Yes	📶 🗑️
2552	Gate	1	Accentronix Door	Eben	+27 []	4	Yes	📶 🗑️



License Scanner

- MENU**
- Global Map Dashboard
 - Global Dashboard
 - Device List
- WILGER PARK ENTRY**
- Dashboard
 - Access Control
 - Users
 - Remotes, Tags & Keypads
 - License Scanners
 - Gate Timers

Wilger Park Entry

Online
Subscription: 01 Feb 2026
Sms Credits: 0
Free Sms: 9
Total Users: 567
Cellswitch Infinity LTE

Sim 1 +2736310314 22 S/N: 8911400000000313

License Scanners Configuration Access Logs Status Logs Error Logs Statistics Sharing

Scanner: All From: 2025-04-01 To: 2025-04-09 This Mo

Scanner Name	Visitor Name	Visitor Contact	Vehicle Reg	Resident Name	Resident Contact	Unit	Reason	Pax	OTP Used	Guard
Wilgerpark	JG SLABBERT	06 []	CF28074 (2025-12-31)				General Contractor	2		
Wilgerpark	M FOURIE	07 []		Louis Caretaker	+27 []	9999	Visitor	1		
Wilgerpark 2	K VENTER	07 []	CY617 (2025-11-30)	Unit B21 Aruschka	+27 []	B021	General Contractor	2		

License Disk Details

Colour: White
 Description: Panel Van / Paneelwa
 License No: CY6170
 Make: VOLKSWAGEN
 Model: VW 357-CADDY DEL
 Vehicle Reg: CXN684K
 Expiry: 2025-11-30

No ID details captured

Driver's License Details

Name: K VENTER
 ID Number: 850 []
 Expiry: 202 []

Access Times

Entry Time: 2025-04-09 12:09:22
 Exit Time: None



Wilgerpark 2	RA SAMUEL	06 []	CAA55190 (2025-09-30)	Unit H32 Dalton	+277633976	H032	Visitor	2	2025-04-09 12:00:18	🟢
Wilgerpark 2	D DE WET	08 []	CAA459671 (2025-12-31)	Unit E15 Darnell	+277315295	E015	Estate Agent	1	2025-04-09 09:56:38	🟢
Wilgerpark 2		06 []	LX09YSGP (2025-07-31)	Unit D20 Alex D	+276336031	D020	Delivery	0	2025-04-09 08:05:50	🟢

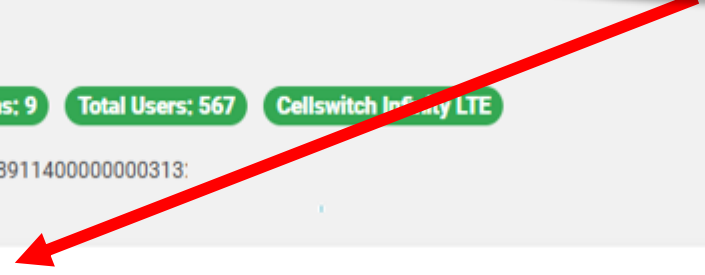
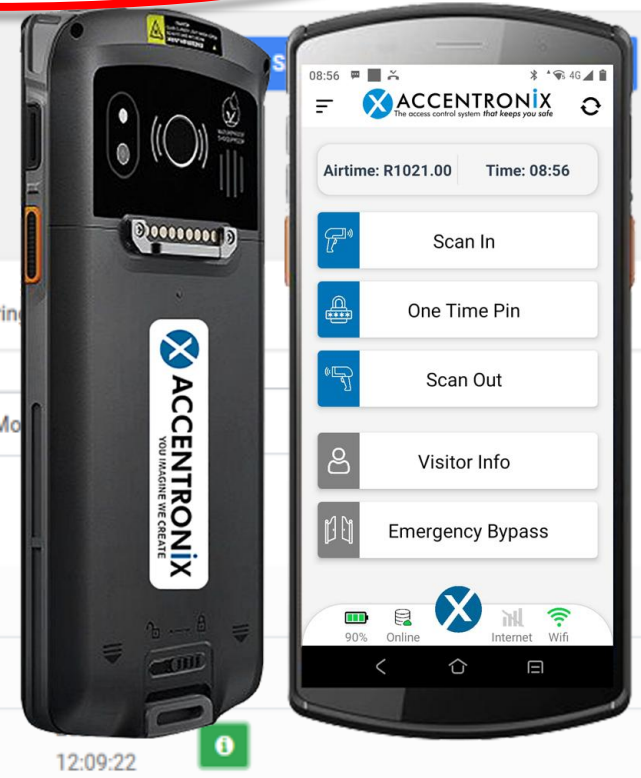

MENU

- 🏠 Global Dashboard
- 📋 Device List

WILLOW GLEN

- 🏠 Dashboard
- 👤 Access Control
- ⚙️ Configuration
 - 📄 General Setup
 - 🔔 Notifications
 - 🔌 Inputs and Outputs
 - 🏠 Google Home
 - 📱 App Buttons
- 📄 Device Logs
- 🔗 Share Device

Willow Glen

Online **Subscription: Feb 2022** **Sms Credits: 308**

Sim 1 📶 +27 📶 26 R132.65

Sim 2 📶 +27 📶 31 R28.70

Google Maps Position

📄 Save Settings 🔄 Update Device

- 📄 Device Info
- 🎵 Audio Settings
- 🏠 Custom Features

Physical Address:
This address will appear in the visitor One-Time-Pin invite message.

Accentronix
2 Windhoek Street
Arauna
Cape Town
7560

Instructions:
Kindly park outside the gate.



MENU

 Global Dashboard

 Device List

 Register Device

48 Online Devices

33 Offline Devices

81 Total Devices

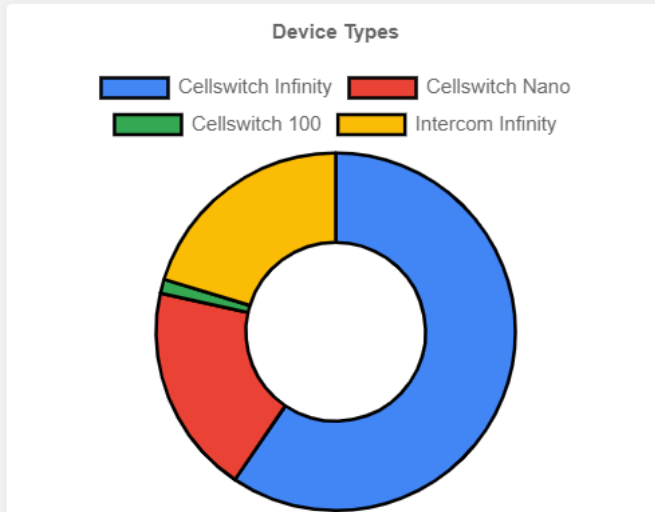

Subscription Renewals

Pay Now

Device Name	MSISDN	Status	Select
Sean Test Intercom	+27660929718	Expired	<input checked="" type="checkbox"/>
Mayo Dam 1	+27766463295	Expiring Soon	<input checked="" type="checkbox"/>
TrainingNano	+27762236198	Expiring Soon	<input checked="" type="checkbox"/>
1 - DEFAULT ACCESS MOBILE	+27000000000	OK	<input type="checkbox"/>
1 - DEFAULT ACCESS REMOTES	+27000000000	OK	<input type="checkbox"/>
1 - DEFAULT ACCESS TAGS	+27000000000	OK	<input type="checkbox"/>
1 - DEFAULT ALARM MONITORING	+27000000000	OK	<input type="checkbox"/>
1 - DEFAULT ALARM STANDALONE	+27000000000	OK	<input type="checkbox"/>
1 - DEFAULT ELECTRIC FENCE	+27000000000	OK	<input type="checkbox"/>
1 - DEFAULT INTERCOM	+27000000000	OK	<input type="checkbox"/>
1 - DEFAULT IRRIGATION	+27000000000	OK	<input type="checkbox"/>
1 - DEFAULT LABTEMP TEMPERATURE	+27000000000	OK	<input type="checkbox"/>
1 - DEFAULT PUMP CONTROL	+27000000000	OK	<input type="checkbox"/>

#00090

Payment total

R 419.75 ZAR

Credit & Cheque card



Instant EFT



Transacting as test@accentronix.co.za, [change](#)

Cancel

Having trouble with your transaction? Let us help you

✉ support@payfast.co.za

PayFast handles secure online payments on behalf of Accentronix. By transacting with PayFast, you acknowledge that you have read and agree to the terms of our [End user agreement](#).



PCI DSS Service Provider Level 1 Compliant

[End user agreement](#) and [Privacy policy](#)

[Contact us](#)

Connection Access Control

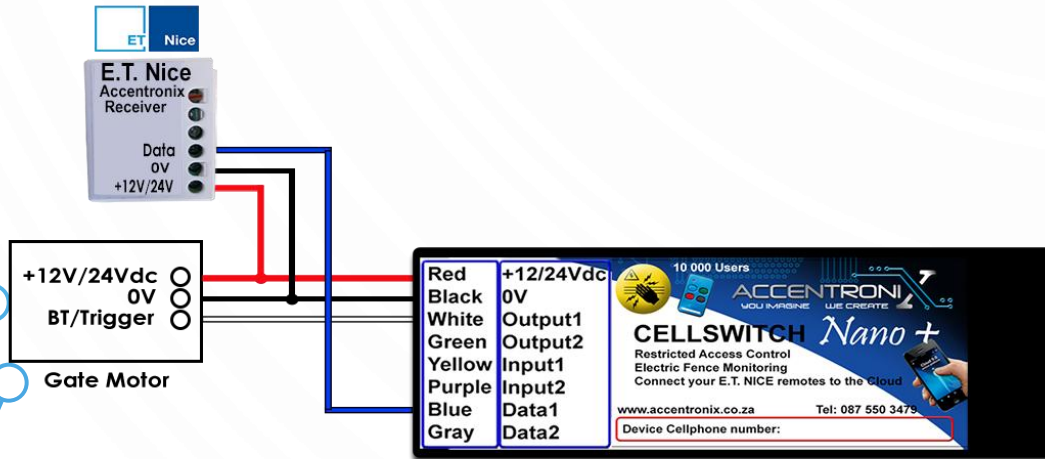
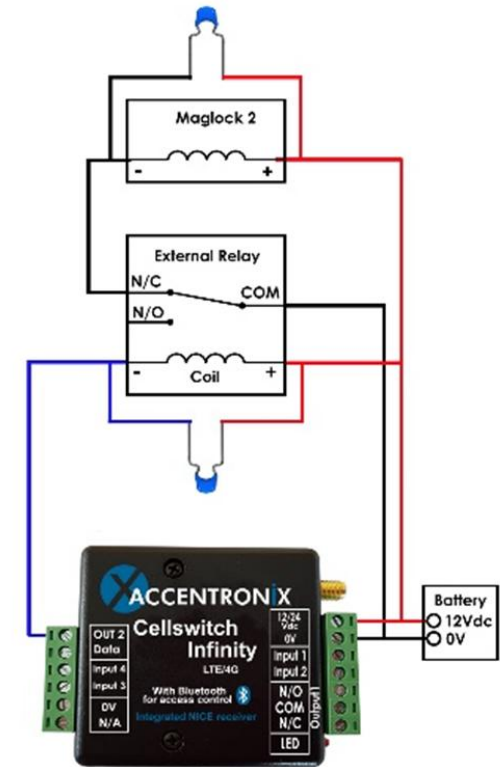
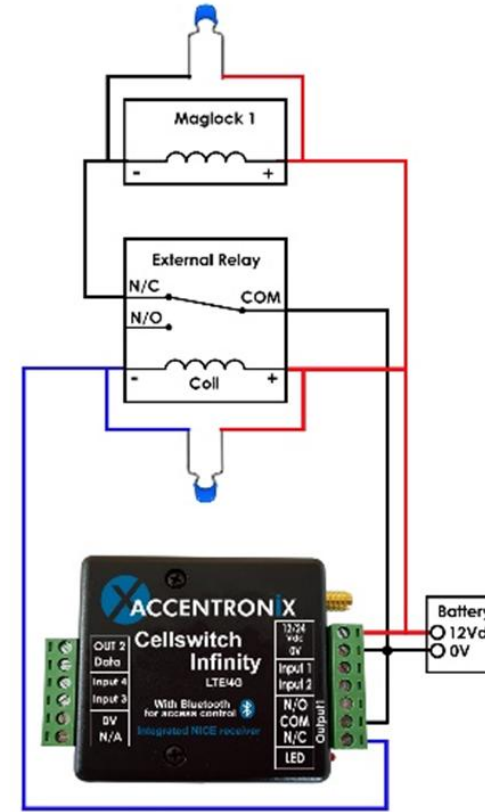

Tag reader Connection

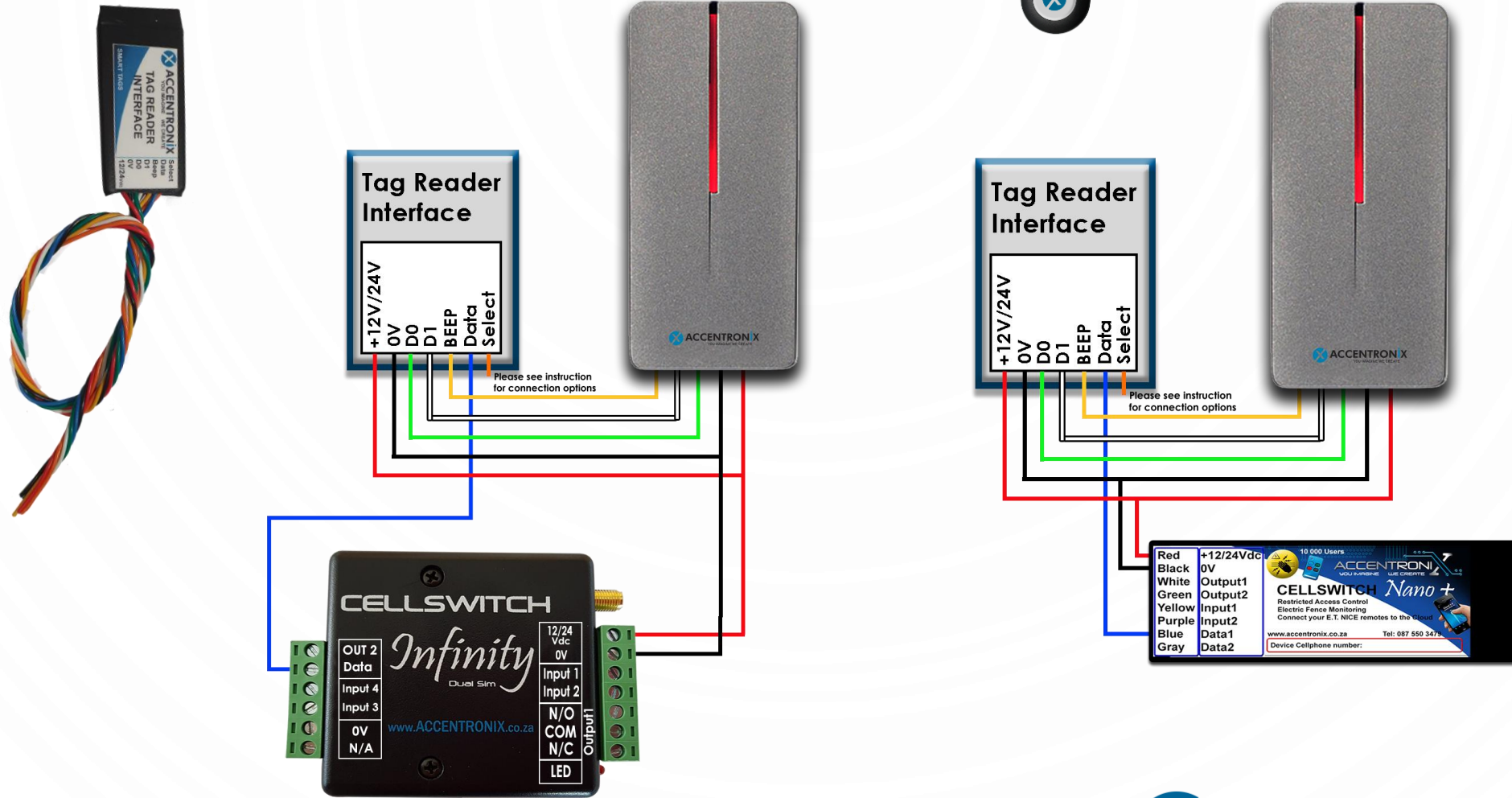

Connection for Electric fence

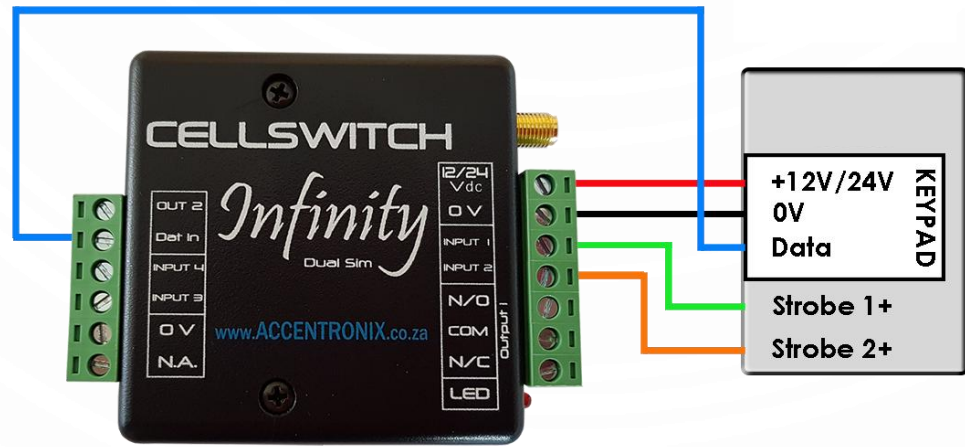
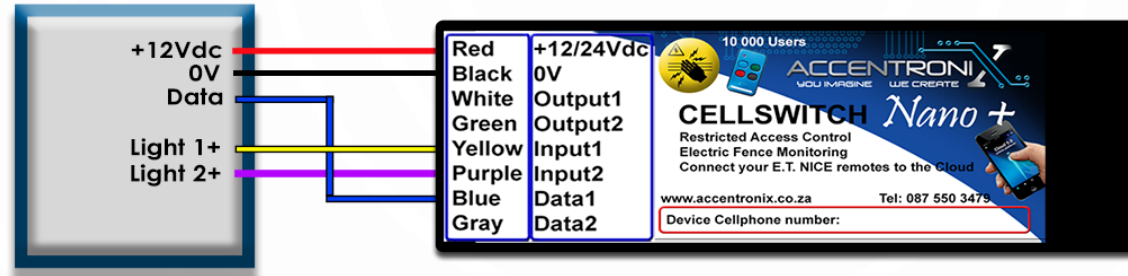

Fault Finding

- LEDs:
- All devices have a GREEN LED and a RED LED.
- On power-up and reset, the GREEN LED will be solid for a few seconds. Afterwards, it will start to flash fast when attaching to a mobile network. It will then start to flash slowly every 3 seconds when connected to Accentronix Cloud Services. At this point, the device should be fully functional.
- - If the GREEN LED stays solid, there is most probably something wrong with the SIM card itself – replace the SIM card.
 - If the GREEN LED keeps flashing fast for more than 5 minutes, load R2 airtime on the SIM card or data, power-cycle the device, and wait at least 5 minutes. If it keeps flashing fast - replace the SIM card.
 - When the device receives a firmware upgrade command, the GREEN LED will flash very fast for about 5-10 minutes. As soon as a new device is registered, the firmware will also automatically start to upgrade.
 - The RED LED indicates events like the device being busy sending in logs, or an output being controlled. If an Electric Fence Energizer is connected correctly, the RED LED will flash constantly.
- Another RED LED located separately from the other GREEN LED and RED LED will flash only while receiving a signal from any E.T. NICE remote.
- Blue EMI Filters on Mag and Striker Locks
- Interference - EMI Cap op Mag en Striker locks



ACCENTRONIX
The access control system *that keeps you safe*

Thank You !!